

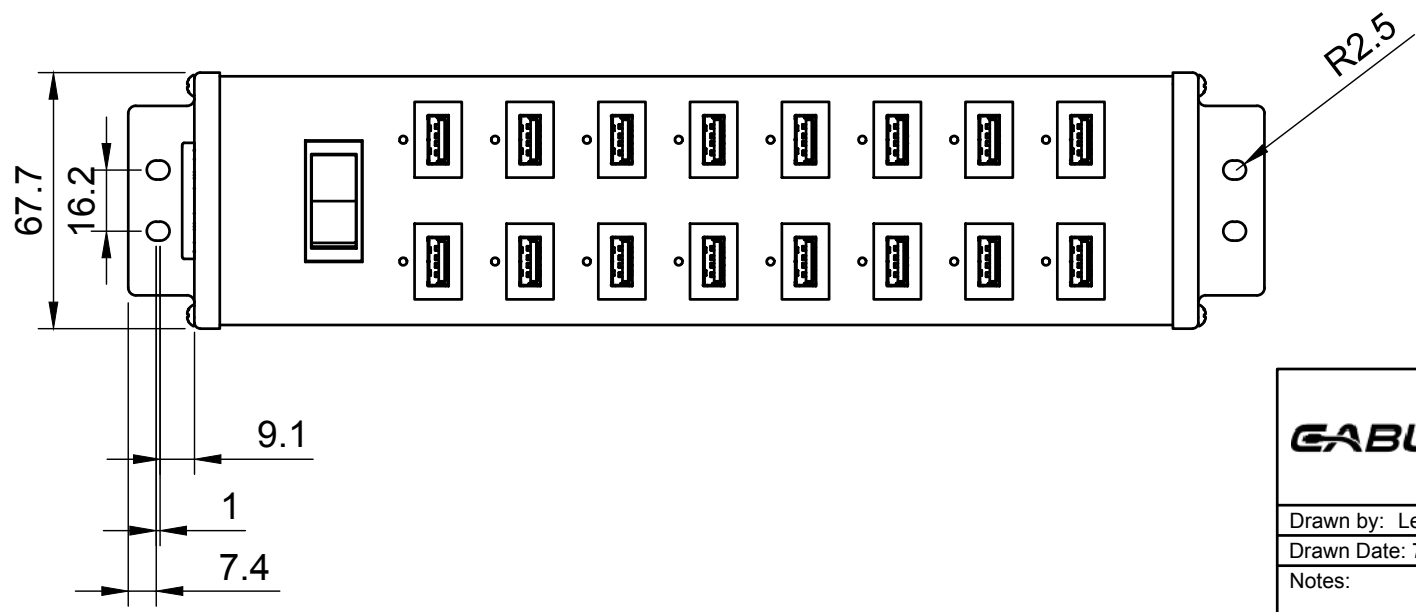

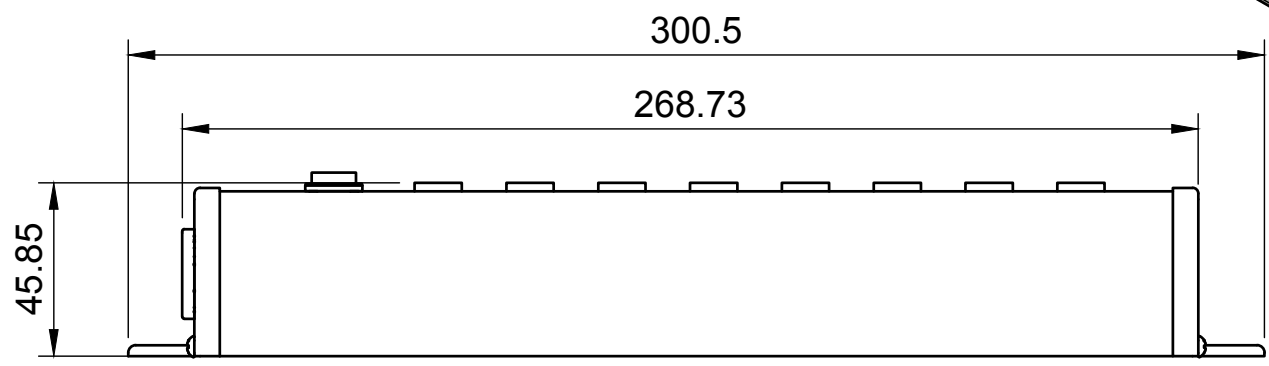

Basic Measurements  
Mounting Holes

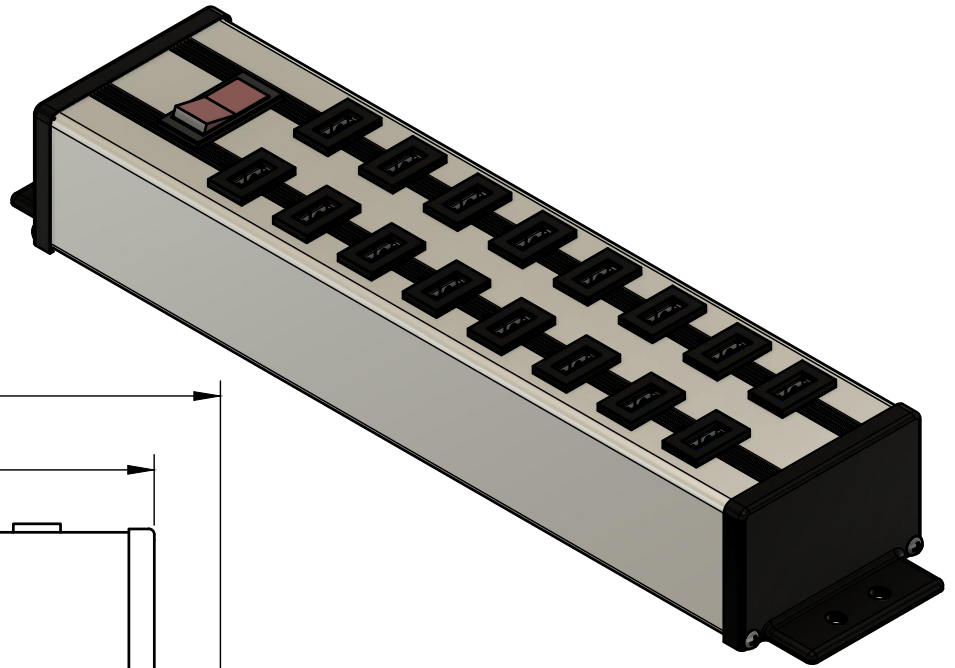

	Model #: CM-USBC-PS	
	Drawn by: Leo Pinto	Scale: 1:2
Drawn Date: 7/1/21	Tolerance: +/- 0.15mm	
Notes:	Contact: support@cablemax.com	
	Web: cablemax.com	
	A4	1/2

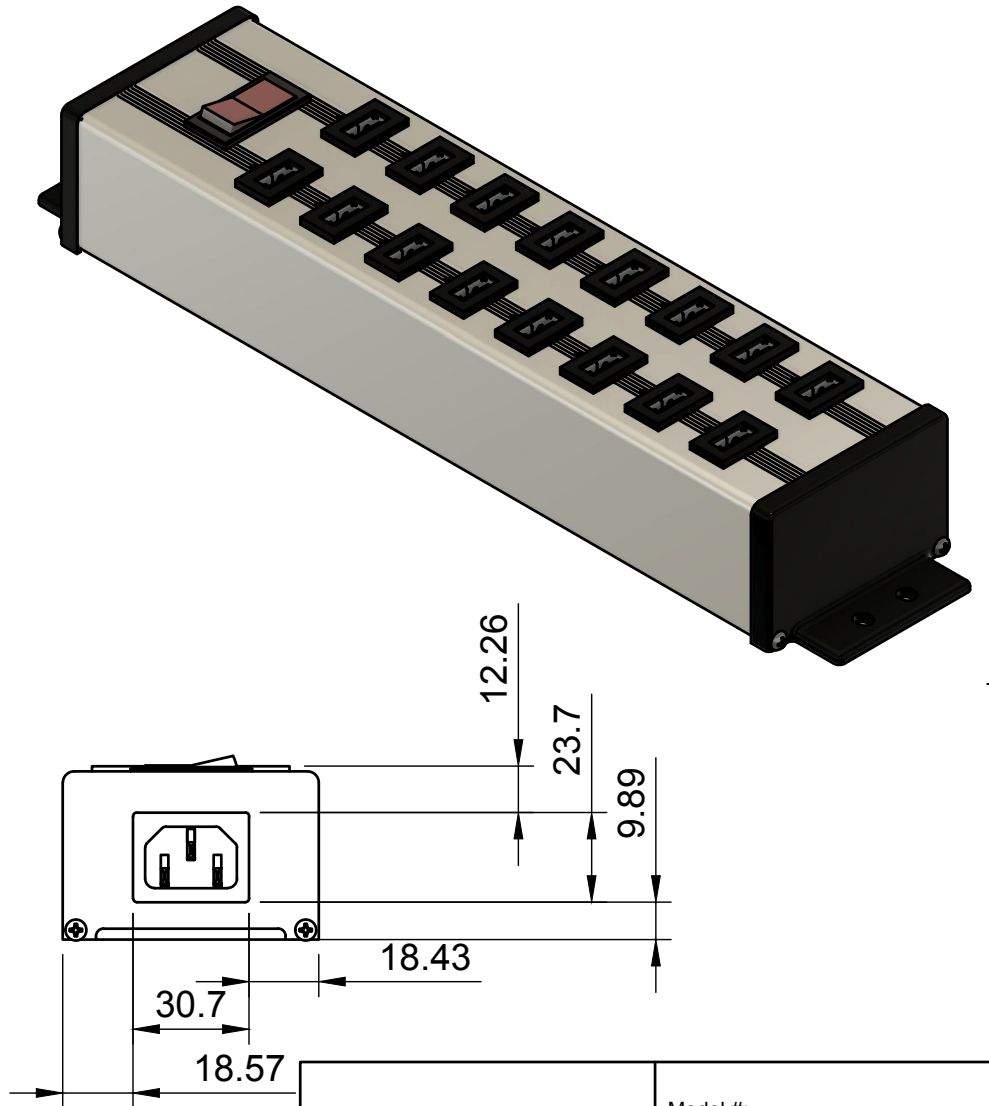
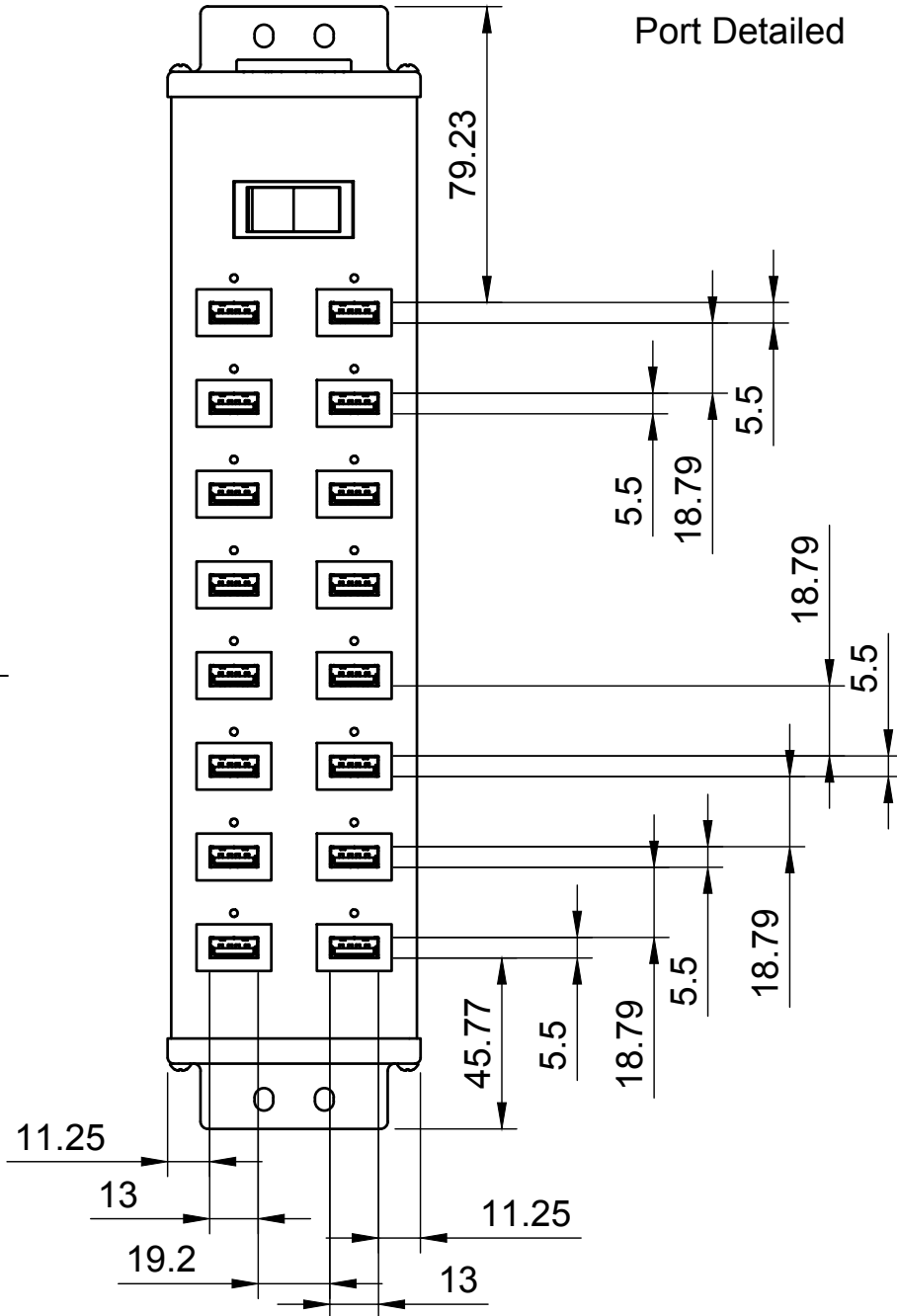
Port Detailed



		Model #:	
		CM-USBC-PS	
Drawn by: Leo Pinto		Scale: 1:2	Units: mm
Drawn Date: 7/1/21		Tolerance: +/- 0.15mm	
Notes:		Contact: support@cablemax.com	
		Web: cablemax.com	
		A4	2/2